

比例式压力控制阀

此系列比例式压力控制阀具有低噪音之压力调整控制功能，并有安全阀之装置。

型号说明

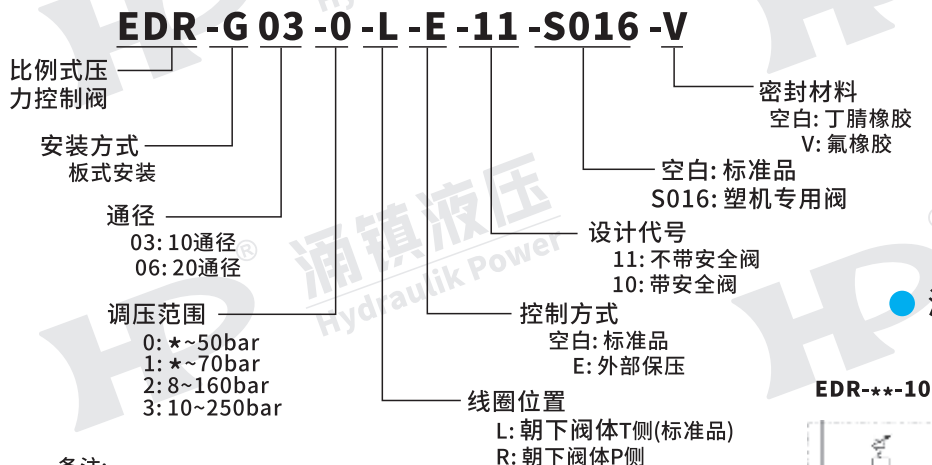

比例阀

● 液压符号

EDR-***-10

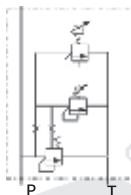

EDR-***-11



EDR-***-E-11



备注:

1. 塑机专用的比例阀(S016)的调压范围只有0和1可选择;
2. 控制方式E只适用于塑机专用的比例阀(S016).

特性参数及曲线

● 规格表

型号	额定压力 (bar)	最低调整压力 (bar)	流量 (l/min)	额定电流 (mA)	调压范围 (bar)	线圈电阻 (Ω)
EDR-G03-0/1/2/3	250	请查阅最低调整压力特性	100	800	0: *~50bar 1: *~70bar 2: 8~160bar 3: 10~250bar	11.2±0.5
EDR-G06-0/1/2/3			200			11.6±0.5

- 1: 正确的阀门安装位置是必须使排气孔朝上，若遇到阀门必须垂直安装时，请联络本公司商洽。
- 2: 为了使压力稳定，需松开朝上的排气孔螺钉将空气排出直到没有气泡后再将螺丝锁紧。
- 3: 当电气控制发生故障时，如临时需要压力供应，这时顺时针调整手动压力推杆，平时恢复原位。
- 4: 回油背压尽量低，油管末端直接插入油槽油面以下。

● 特性

型号	EDR-G03-**-11	EDR-G06-**-11
最高工作压力(bar)	250	250
最大流量(l/min)	100	200
压力调节范围(bar)	2:8~160 3:10~250	2:8~160 3:10~250
额定电流(mA)	770(8~160bar时) 800(10~250bar时)	780(8~160bar时) 800(10~250bar时)
线圈电阻(Ω)	EDR-G03/G06-0/1 11.2±0.5	EDR-G03/G06-2/3 11.6±0.5
滞环性	<3%	<3%
重复性	0.5%	0.5%
重量(kg)	5.6	6.3

备注: 为避免预先设定的压力出现不稳定，应采用大于3 l/min的流量。

● 应答特性曲线

测试条件: 粘度: 35cSt; 温度: 50°C

EDR-G03-0-11

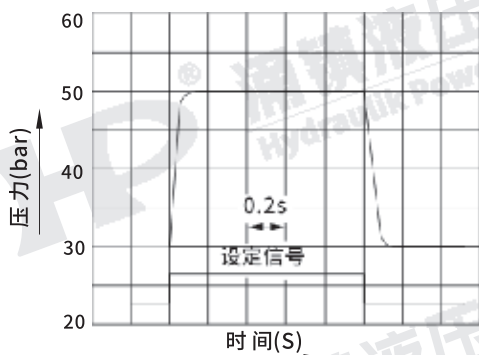

EDR-G03-1-11

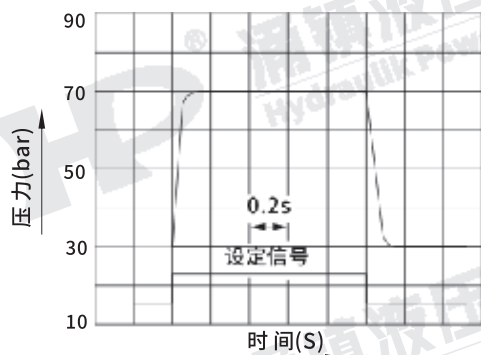

EDR-G03-2-11

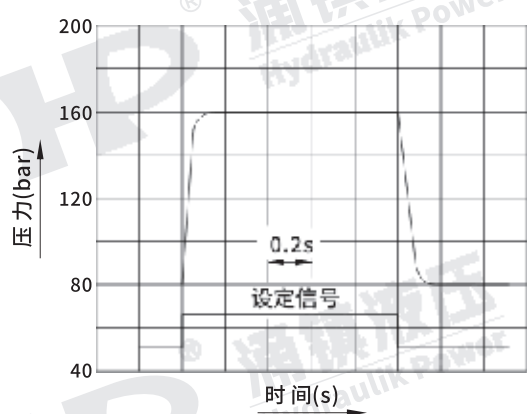

EDR-G03-3-11

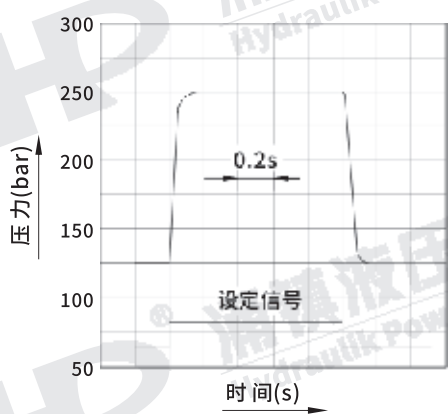

EDR-G06-0-11

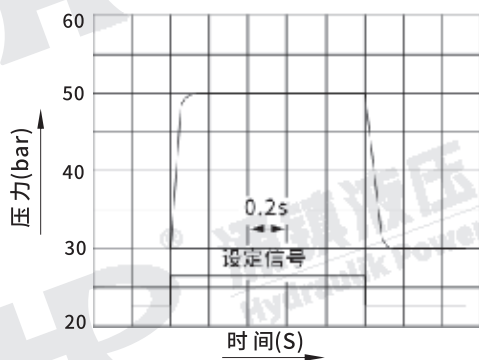

EDR-G06-1-11

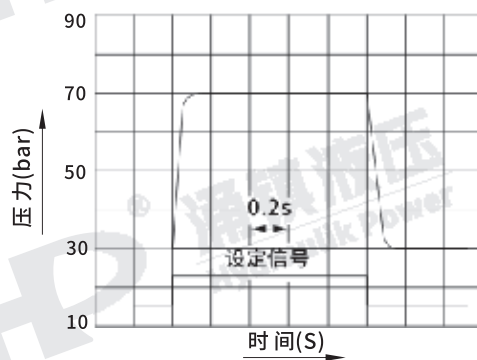

EDR-G06-2-11

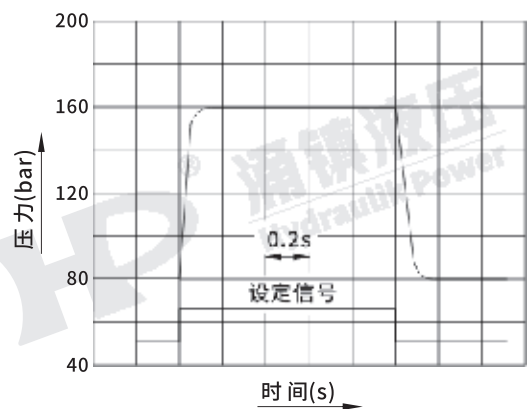

EDR-G06-3-11

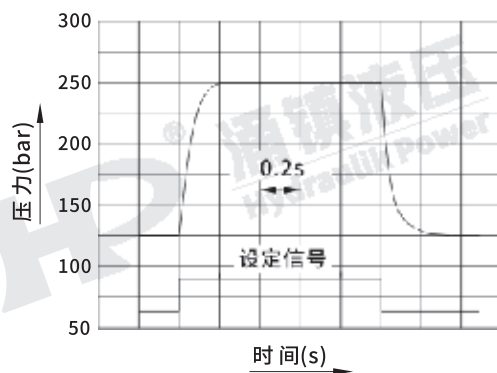

● 最低调整压力特性

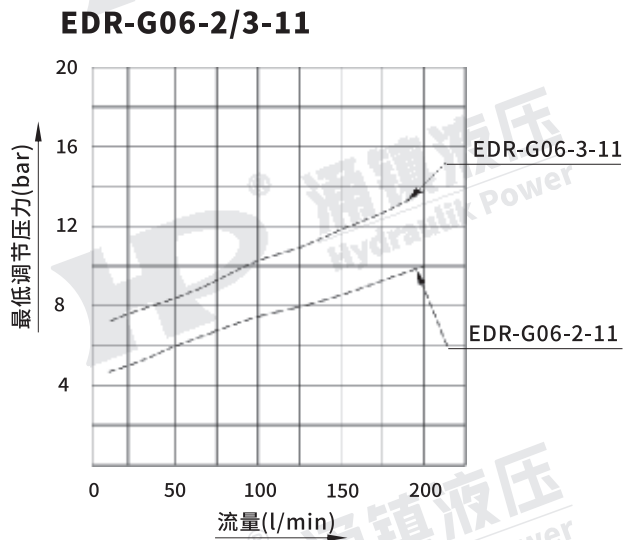
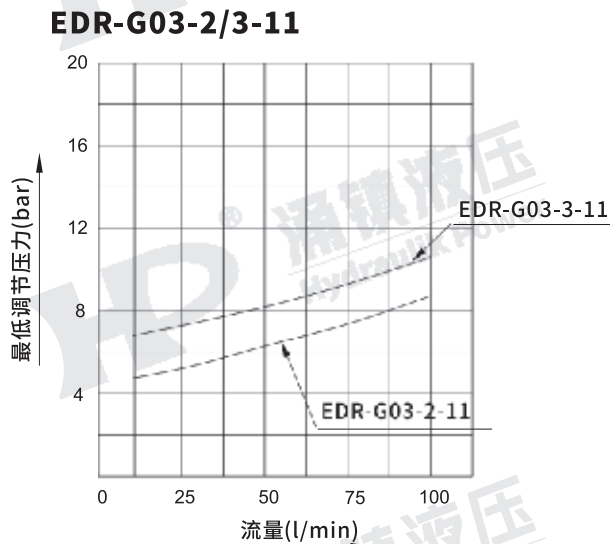
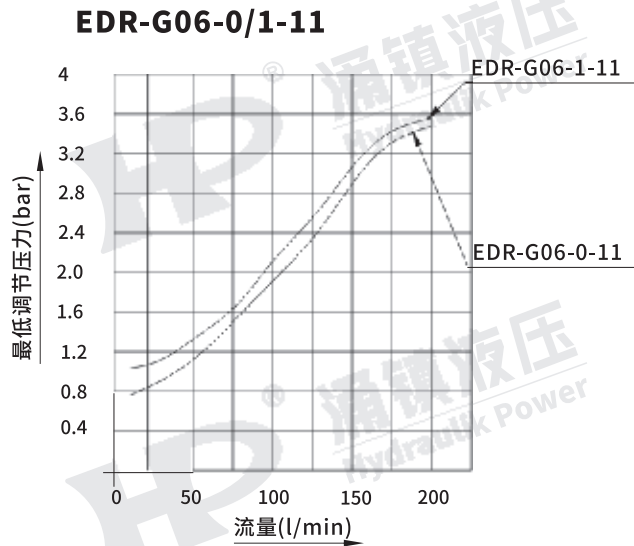
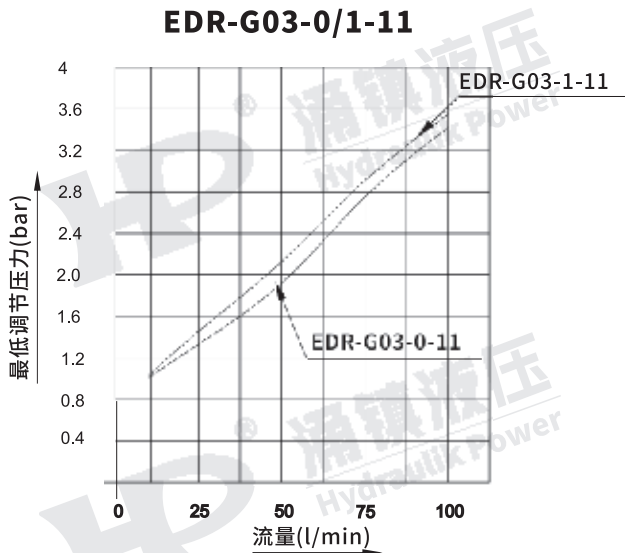

● 输入电流-压力特性

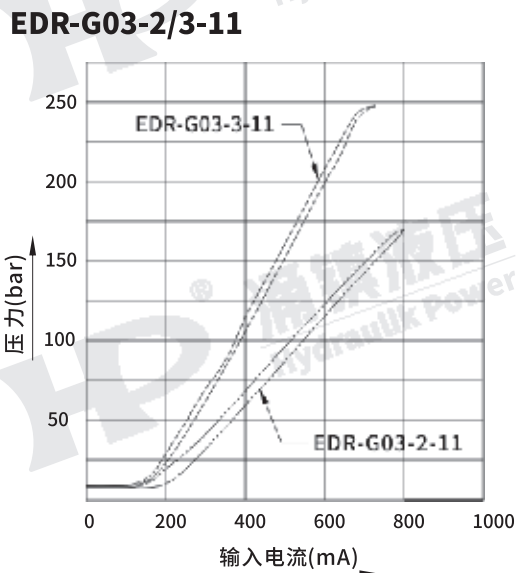
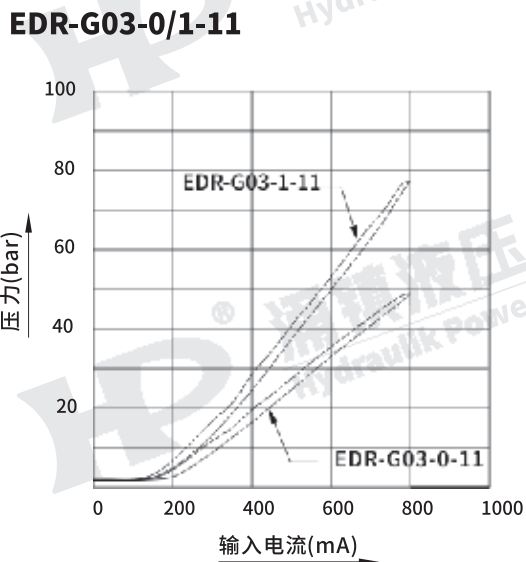

EDR-G06-0/1-11

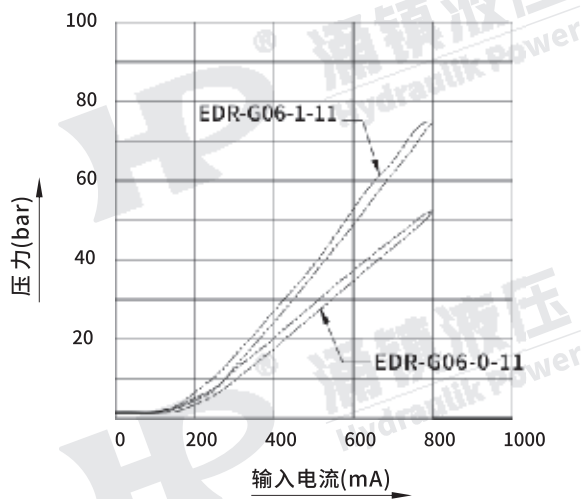

EDR-G06-2/3-11

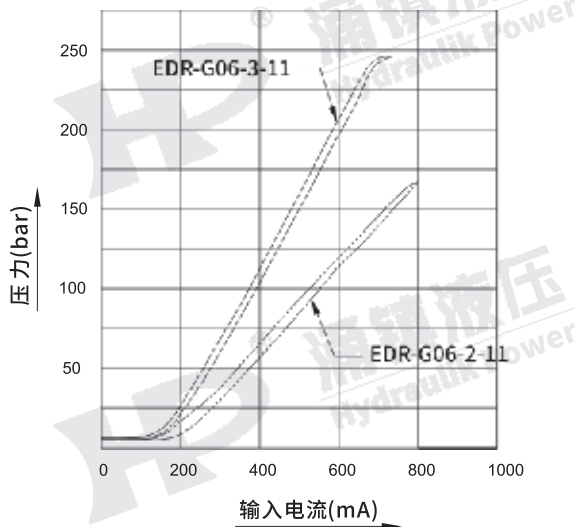

● 溢流负载特性曲线

EDR-G03-3-11

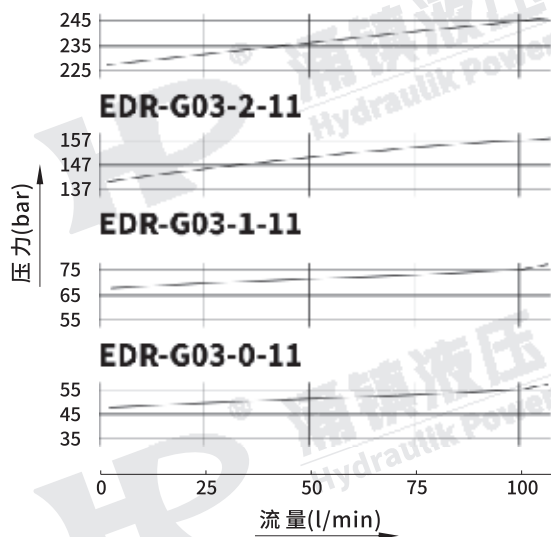

EDR-G03-2-11

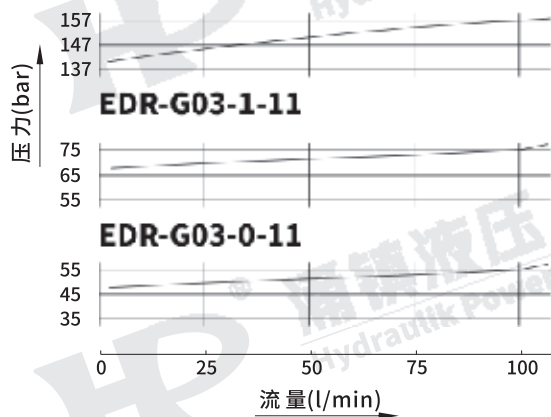

EDR-G03-1-11

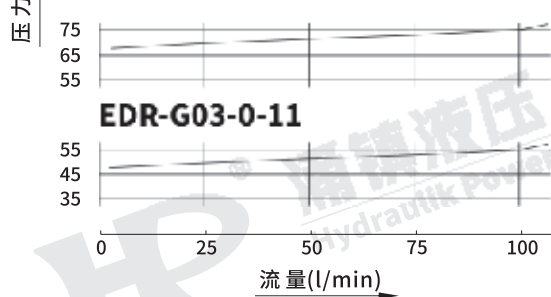

EDR-G03-0-11

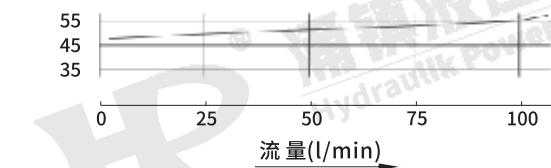

EDR-G06-3-11

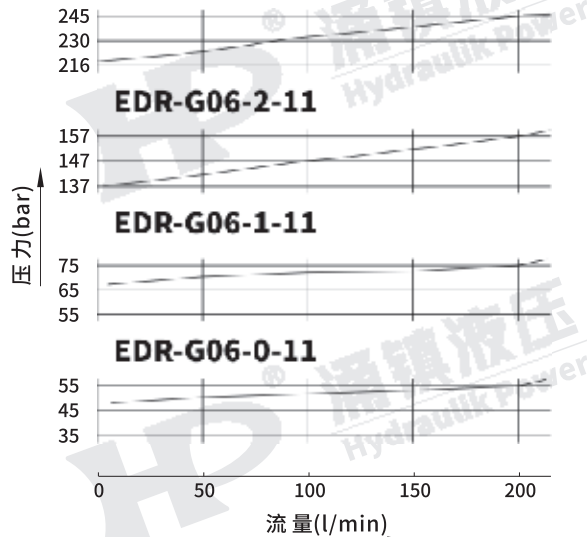

EDR-G06-2-11

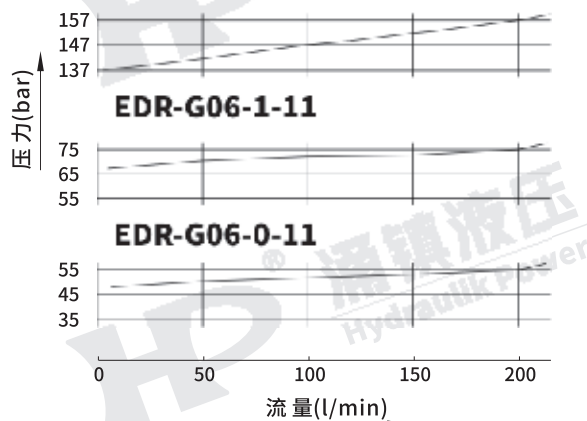

EDR-G06-1-11

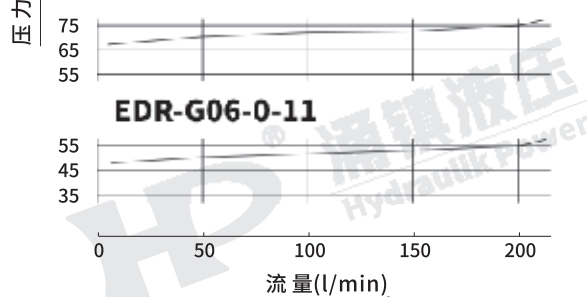

EDR-G06-0-11

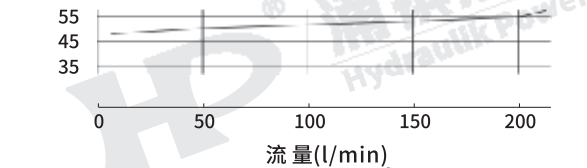

● 粘度-压力特性

EDR-G03-1-11

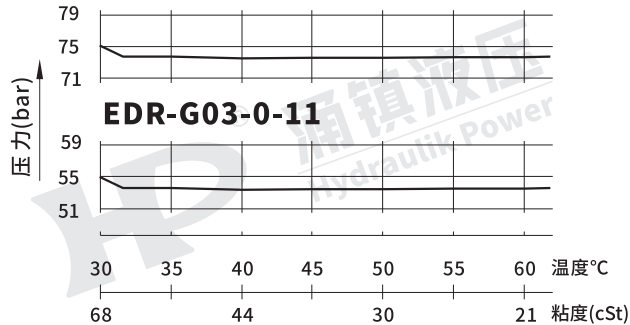

EDR-G03-0-11

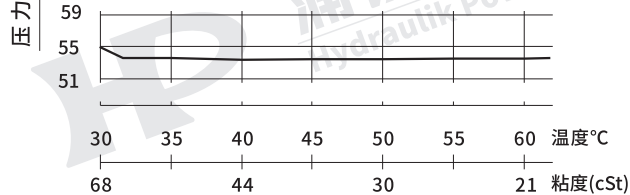

EDR-G03-3-11

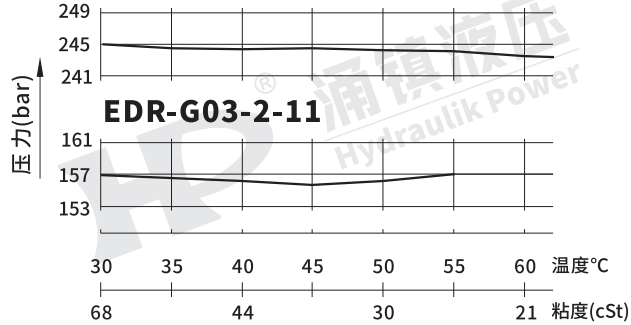

EDR-G03-2-11

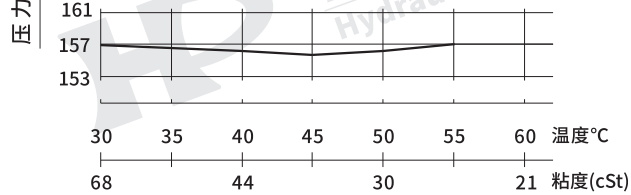

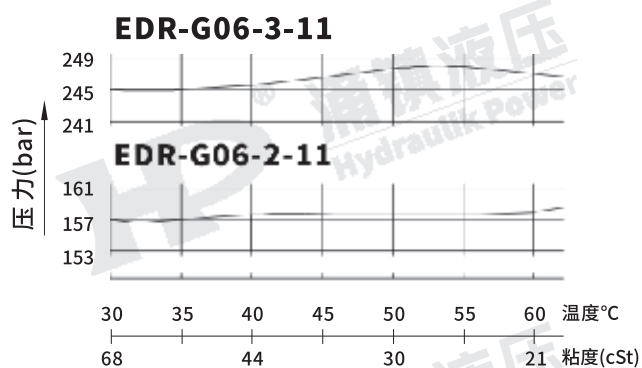
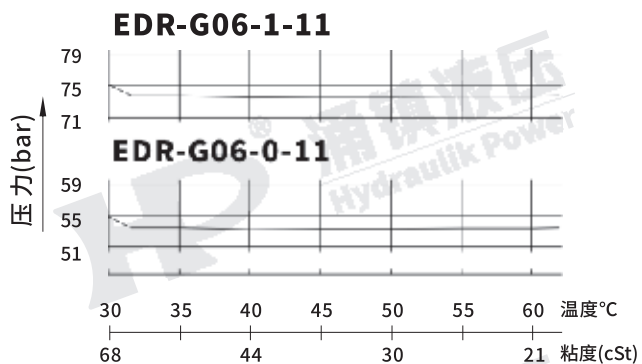

外形尺寸图

单位: mm

● EDR-G03-L-11/10

EDR-G03系列阀安装面: ISO 6264-AR-06-2-A

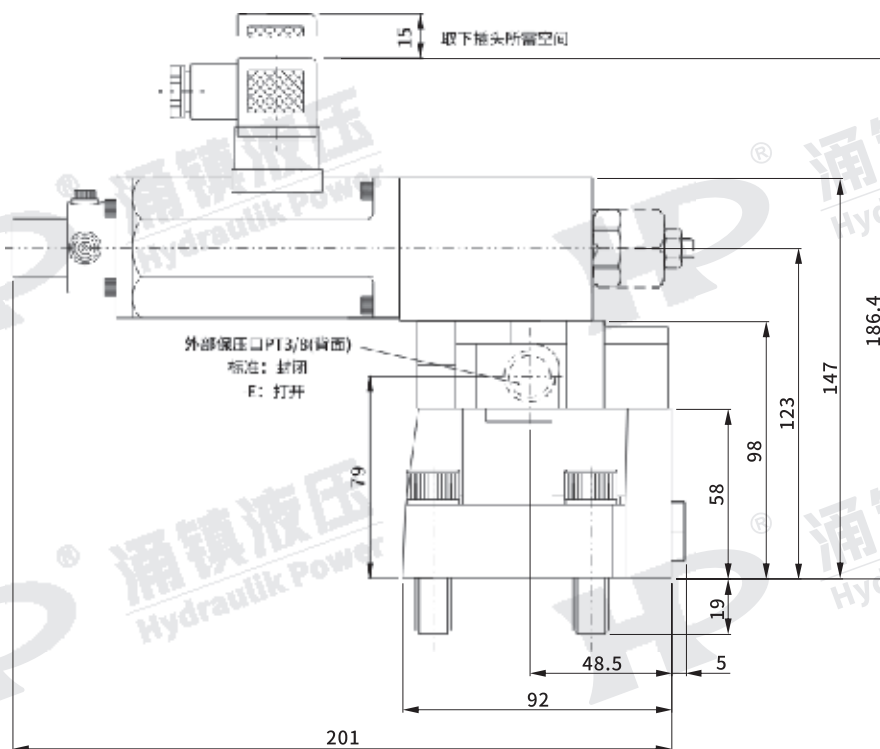
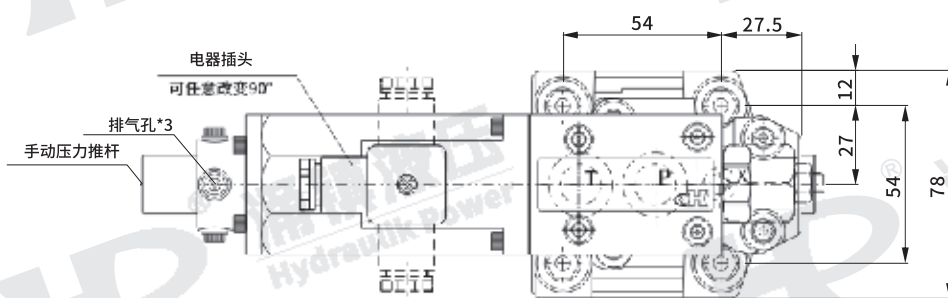

外形尺寸图

单位: mm

● EDR-G06-L-11/10

EDR-G06系列阀安装面: ISO 6264-AS-08-2-A

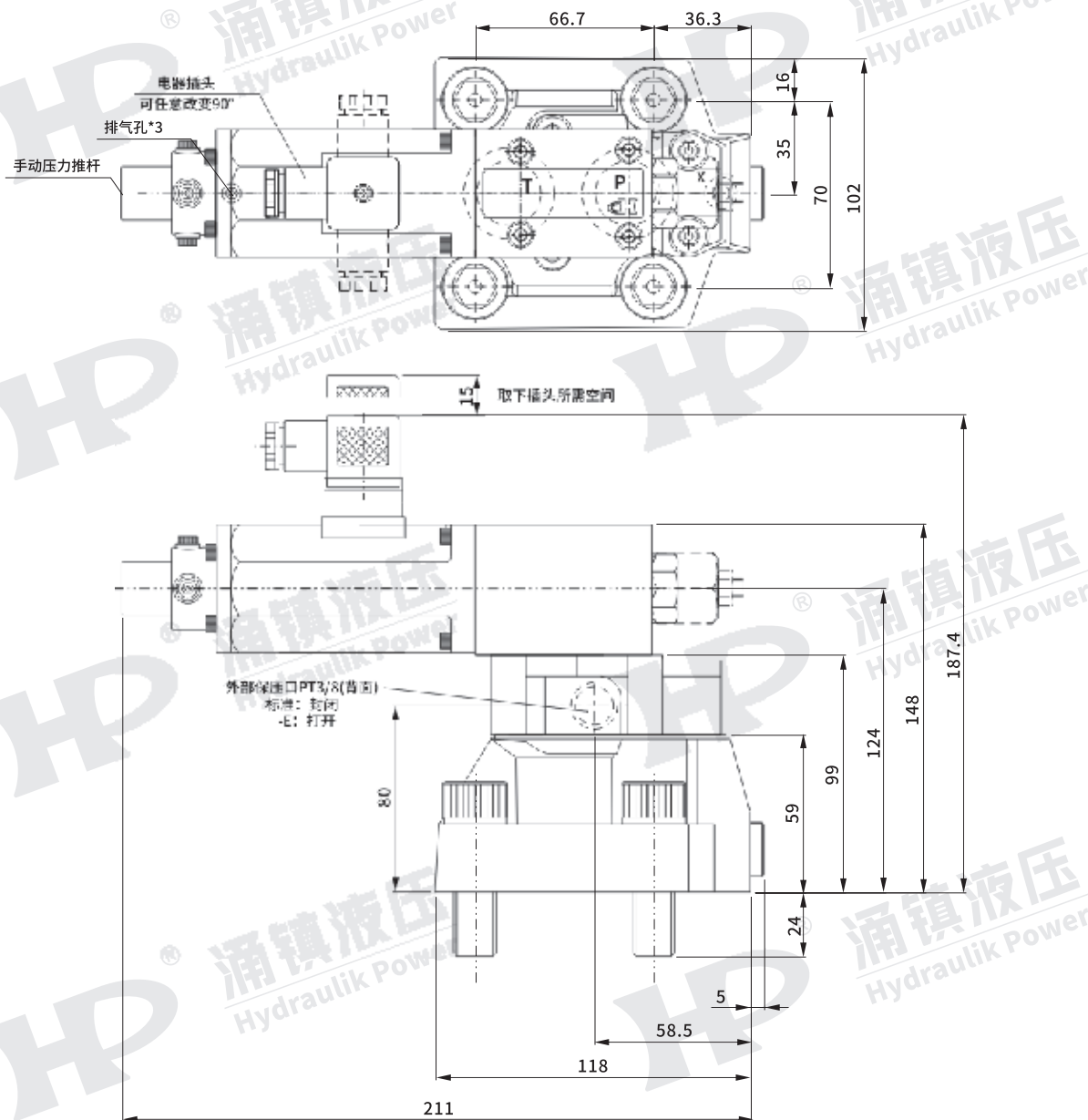

● 安装附件

零件名称	EDR-G03-**-11	EDR-G06-**-11	数量
内六角螺钉	M12×45L	M16×50L	4
安装面O型圈	AS568-012 Hs90	AS568-012 Hs90	1
	AS568-115 Hs90	AS568-216 Hs90	2
安装阀板	MF-04系列	MF-06系列	